

# Design and Installation Manual for Infiltrator® Chambers in Florida

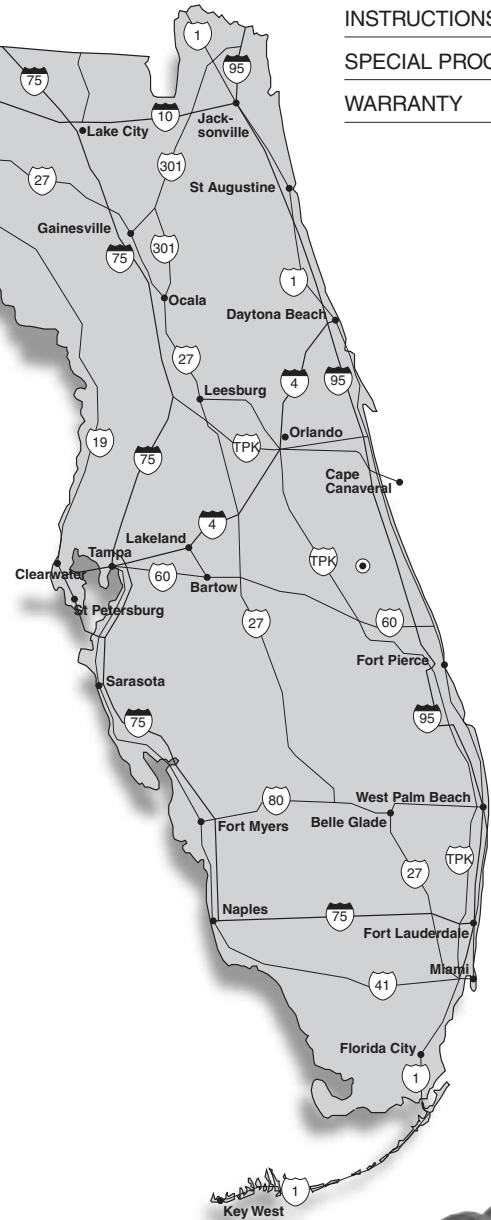

INTRODUCTION	2
PRODUCTS	3
SYSTEM SIZING	5
CHAMBER CONFIGURATIONS	7
INSTALLATION INSTRUCTIONS	9
SPECIAL PROCEDURES	14
WARRANTY	16

**MADE IN THE USA**

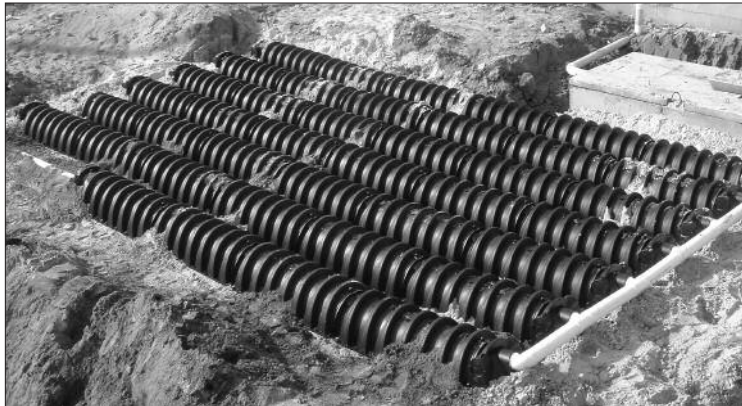
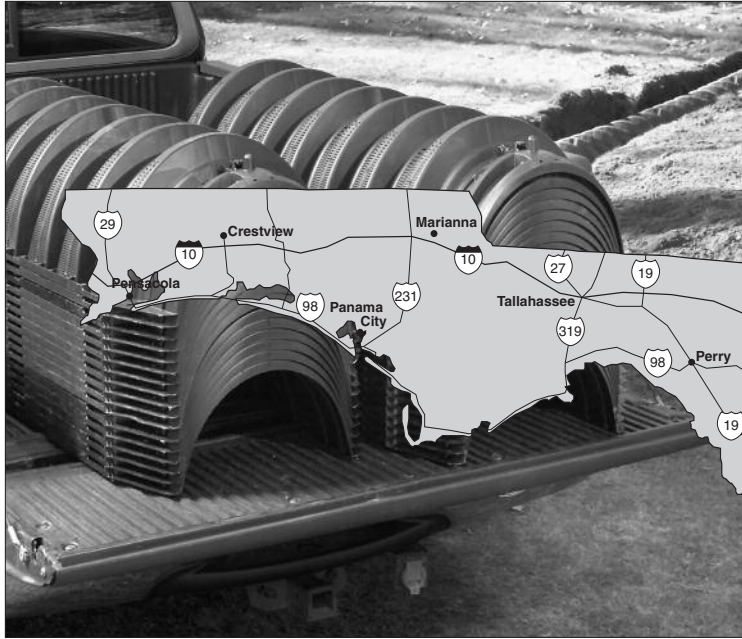

JULY 2006

The purpose of this manual is to provide design and installation information pertinent to the use of Quick4® EQ36 StraightLock™, Quick4 Equalizer® 36 and Equalizer 36 QuickCut™ chambers in trench and bed applications in Florida. Quick4 Equalizer 24, Equalizer 24 and Equalizer 36 chambers are also approved for use in Florida. Only an Infiltrator Systems certified contractor can install these chambers.

For more specific design information, please contact Infiltrator Systems at 1-800-221-4436 or your local Florida Infiltrator Systems representative.

## Quick4 EQ36 StraightLock Chamber

The evolutionary patent-pending Quick4 EQ36 StraightLock Chamber is specifically designed for use in bed applications. The StraightLock connection forms a rigid joint that allows chamber rows to remain straight and resistant to movement during backfill. The MultiPort™ end cap allows multiple piping options and eliminates pipe fittings.

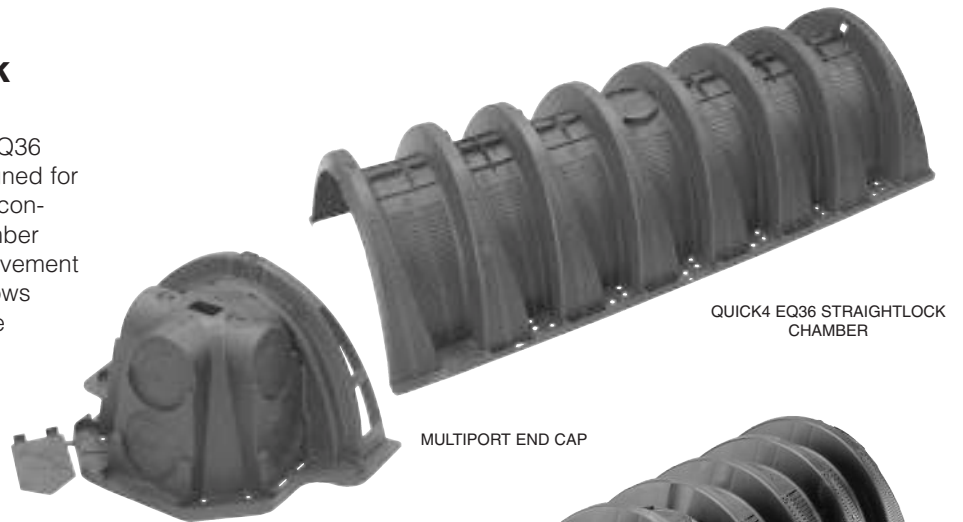

## Quick4 Equalizer® 36 Chamber

The patent-pending Quick4 Equalizer 36 Chamber can be installed in a 24-inch wide trench. The chamber offers advanced contouring capability with its Contour Swivel Connection™. The patent-pending MultiPort End Cap with its six molded-in high and low inlets allows for maximum piping flexibility.

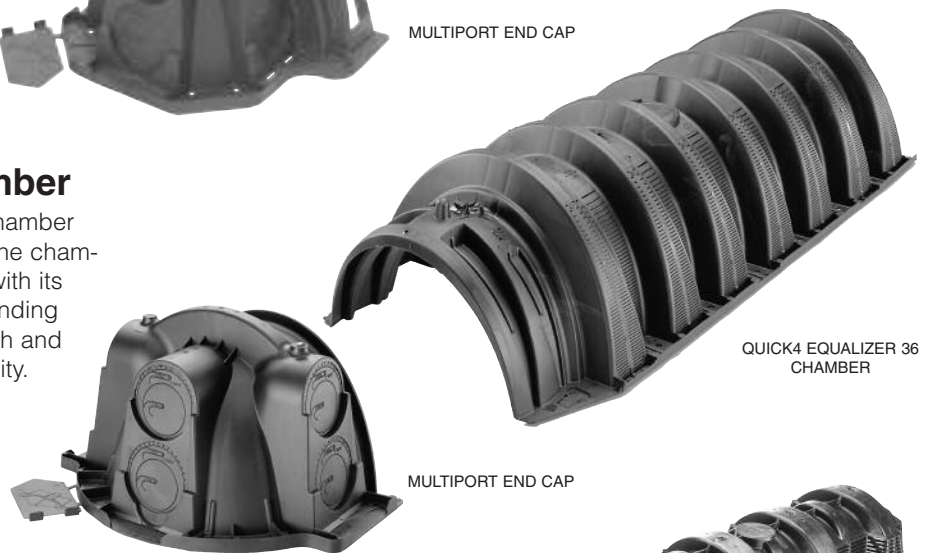

## Equalizer 36 QuickCut Chamber

The Equalizer 36 QuickCut chamber features a unique premarked cut line, allowing you to create two chambers that are over 4 feet in length. This product innovation offers increased design and installation flexibility, while maintaining structural integrity and long-term performance. The chamber provides greater options for all sites, including tight or sloped lots.

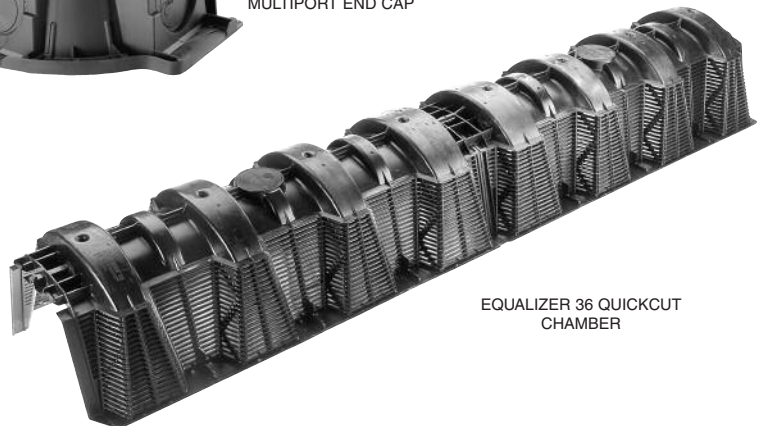

## Quick4 EQ36 StraightLock Chambers

### Side and End Views

(Not to scale)

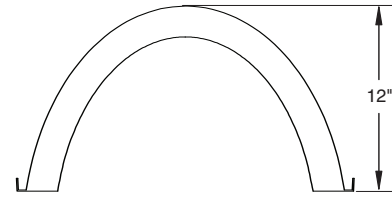
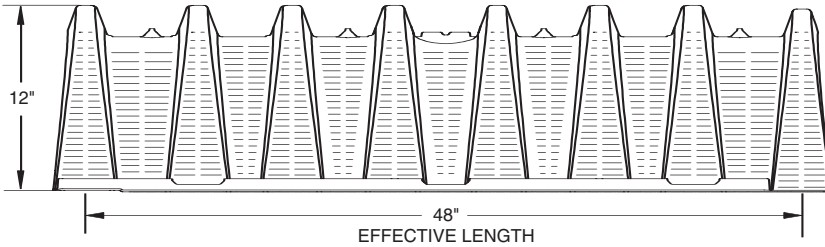

### MultiPort End Cap

(Not to scale)

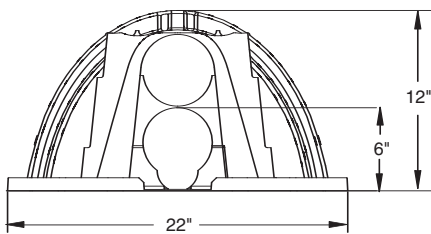

FRONT VIEW

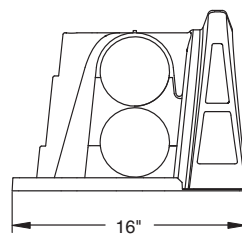

SIDE VIEW

### Quick4 EQ36 StraightLock nominal chamber specifications

Size (W x L x H)	22" x 53" x 12"
Effective Length	48"
Invert Height	6"

## Quick4 Equalizer 36 Chambers

### Side and End Views

(Not to scale)

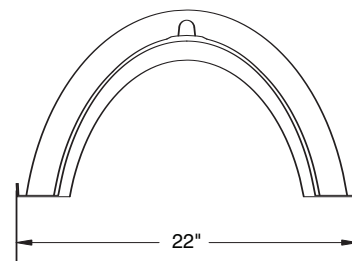
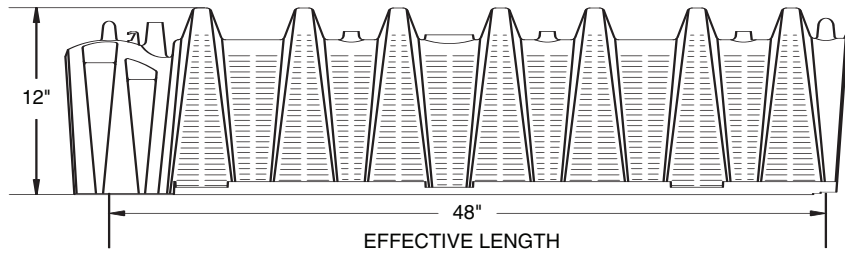

### MultiPort End Cap

(Not to scale)

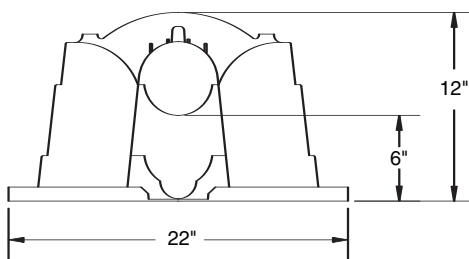

FRONT VIEW

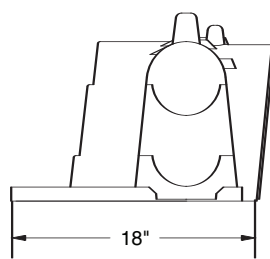

SIDE VIEW

### Quick4 Equalizer 36 nominal chamber specifications

Size (W x L x H)	22" x 53" x 12"
Effective Length	48"
Invert Height	6"

## Equalizer 36 QuickCut Chambers

### Side and End Views

(Not to scale)

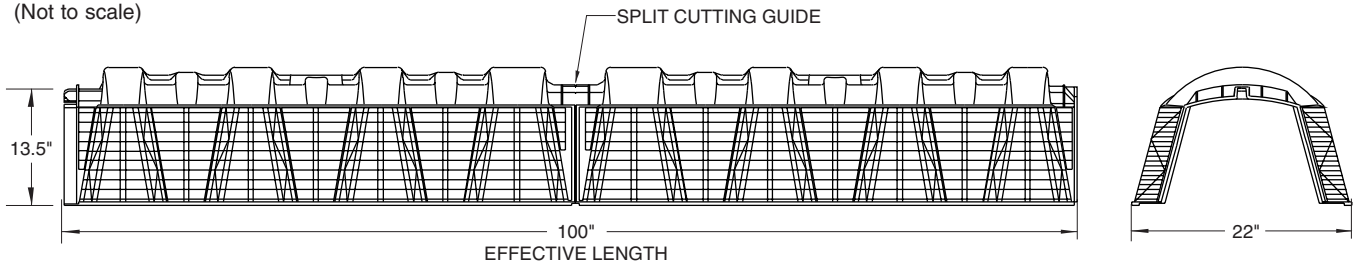

### END PLATES (not to scale)

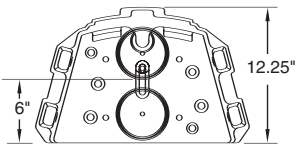

**6" INVERT**  
**PART # EQ36P6**

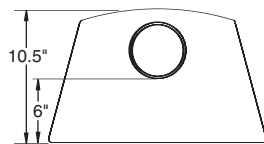

**PART # EQ36-EN**

### Equalizer 36 QuickCut nominal chamber specifications

Size (W x L x H)	22" x 100" x 13.5"
Effective Length	100"
Invert Height	6"

## Quick4 Equalizer 24 Chambers (in select areas)

### Side and End Views

(Not to scale)

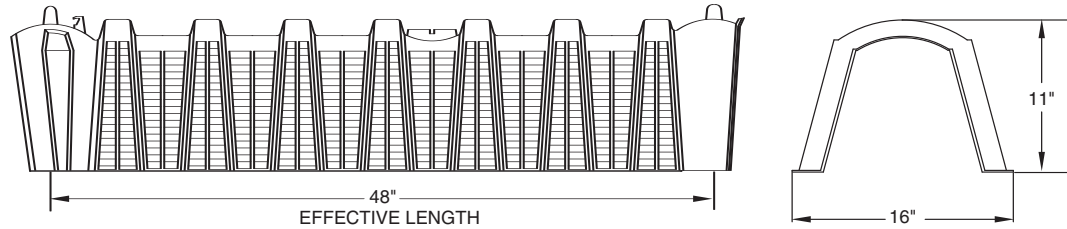

### MultiPort End Cap

(Not to scale)

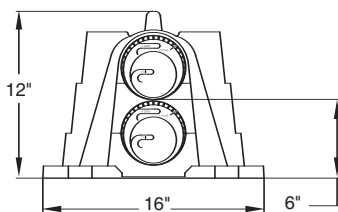

**FRONT VIEW**

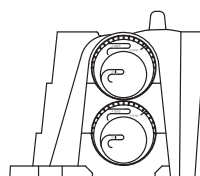

**SIDE VIEW**

### Quick4 Equalizer 24 nominal chamber specifications

Size (W x L x H)	16" x 53" x 11"
Effective Length	48"
Invert Height	6"

## Chamber System Sizing

**TABLE 1: CHAMBER RATINGS**

Chamber (Type & Size)	Trench (Width in Inches)	Rating (Ft <sup>2</sup> /Chamber)
Quick4 EQ36 StraightLock 22" x 48" x 12"	24	12*
Quick4 Equalizer 36 22" x 48" x 12"	24	12*
Equalizer 36 QuickCut 22" x 100" x 13.5"	24	25*
Quick4 Equalizer 24 16" x 48" x 11"	18-24	8*
Side by Side Quick4 Equalizer 24	36	8.57

\*Same rating applies in a bed configuration with approximately 4 to 6-inch separation between chambers.

**TABLE 2: EQUALIZER 36 (EQ36) BED SYSTEMS WIDTH USING 4-INCH SEPARATION<sup>1</sup>**

No. of Rows	Bed Width
2	4'
3	6' 2"
4	8' 4"
5	10' 6"
6	12' 8"
7	14' 10"
8	17'
9	19' 2"
10	21' 4"

<sup>1</sup>Measurements are to outside edge of chamber.

Note: Add 2'-2" for each additional row in excess of 10 rows.

Note on replaced fill: The one foot perimeter area required for a dig-out around the system should be measured from the end of the chambers and not the end plates. The end plates are not given any credit for drainfield area and can be placed within the soil replacement perimeter.

**TABLE 3: EQUALIZER 36 (EQ36) TRENCH SYSTEMS WIDTH USING 2-FOOT SEPARATION\***

No. of Trenches	System Width
2	5' 8"
3	9' 6"
4	13' 4"
5	17' 2"
6	21' 0"
7	24' 10"
8	28' 8"
9	32' 6"
10	36' 4"

Note: Add 3'-10" for each additional trench in excess of 10.

\* Measurements are outside shoulder to outside shoulder.

## Chamber System Sizing

**TABLE 4: QUICK4 EQ36 STRAIGHTLOCK AND QUICK4 EQUALIZER 36 CHAMBER LENGTHS AND RATING**

No. of Chambers	Length	Rating (Ft <sup>2</sup> /chamber)
1	4.0	12.0
2	8.0	24.0
3	12.0	36.0
4	16.0	48.0
5	20.0	60.0
6	24.0	72.0
7	28.0	84.0
8	32.0	96.0
9	36.0	108.0
10	40.0	120.0
11	44.0	132.0
12	48.0	144.0
13	52.0	156.0
14	56.0	168.0
15	60.0	180.0
16	64.0	192.0
17	68.0	204.0
18	72.0	216.0
19	76.0	228.0
20	80.0	240.0
21	84.0	252.0
22	88.0	264.0
23	92.0	276.0
24	96.0	288.0
25	100.0	300.0
26	104	312.0
27	108	324.0
28	112	336.0
29	116	348.0
30	120	360.0
31	124	372.0
32	128	384.0
33	132	396.0
34	136	408.0
35	140	420.0
36	144	432.0
37	148	444.0
38	152	456.0
39	156	468.0

*Note: For minimum sizing on standard and split systems (grey water) refer to Chapter 64E-6 Florida Administrative Code.*

**TABLE 5: EQUALIZER 36 QUICKCUT CHAMBER LENGTHS AND RATING**

No. of Chambers	Length	Rating (Ft <sup>2</sup> /chamber)
1	8' 4"	25.0
1½	12' 6"	37.5
2	16' 8"	50.0
2½	21' 1"	62.5
3	25' 0"	75.0
3½	29' 5"	87.5
4	33' 7"	100.0
4½	37' 9"	112.5
5	42' 1"	125.0
5½	46' 3"	137.5
6	50' 0"	150.0
6½	54' 7"	162.5
7	58' 9"	175.0
7½	63' 2"	187.5
8	67' 4"	200.0
8½	71' 6"	212.5
9	75' 0"	225.0
9½	80' 0"	237.5
10	84' 2"	250.0
10½	88' 4"	262.5
11	92' 6"	275.0
11½	96' 8"	287.5
12	100' 0"	300.0
12½	105' 3"	312.5
13	109' 5"	325.0
13½	113' 7"	337.5
14	117' 9"	350.0
14½	122' 1"	362.5
15	126' 3"	375.0
15½	130' 5"	387.5
16	134' 7"	400.0
16½	138' 9"	412.5
17	143' 1"	425.0
17½	147' 4"	437.5
18	151' 6"	450.0
18½	155' 8"	462.5
19	160' 0"	475.0
19½	164' 2"	487.5
20	168' 4"	500.0

*Note: Full EQ36 QuickCut Chambers have a rating of 25 ft<sup>2</sup>, half chambers have a rating of 12.5 ft<sup>2</sup>.*

# Quick4 Equalizer 36 Bed Configurations

**CROSS SECTION**  
(not to scale)

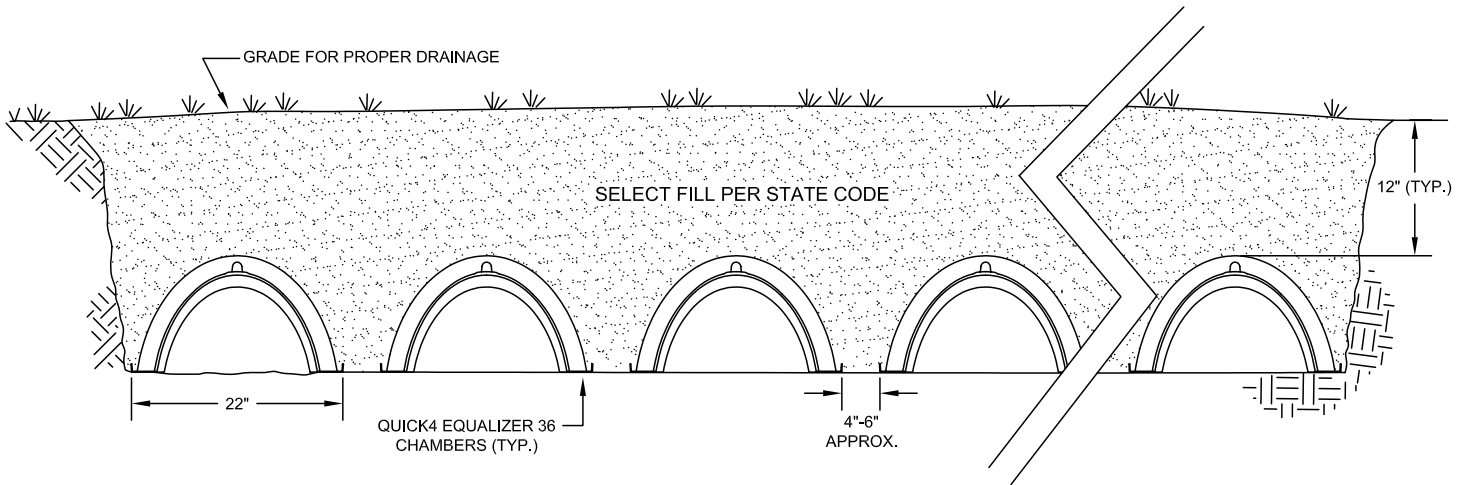

**PLAN VIEW**  
(not to scale)

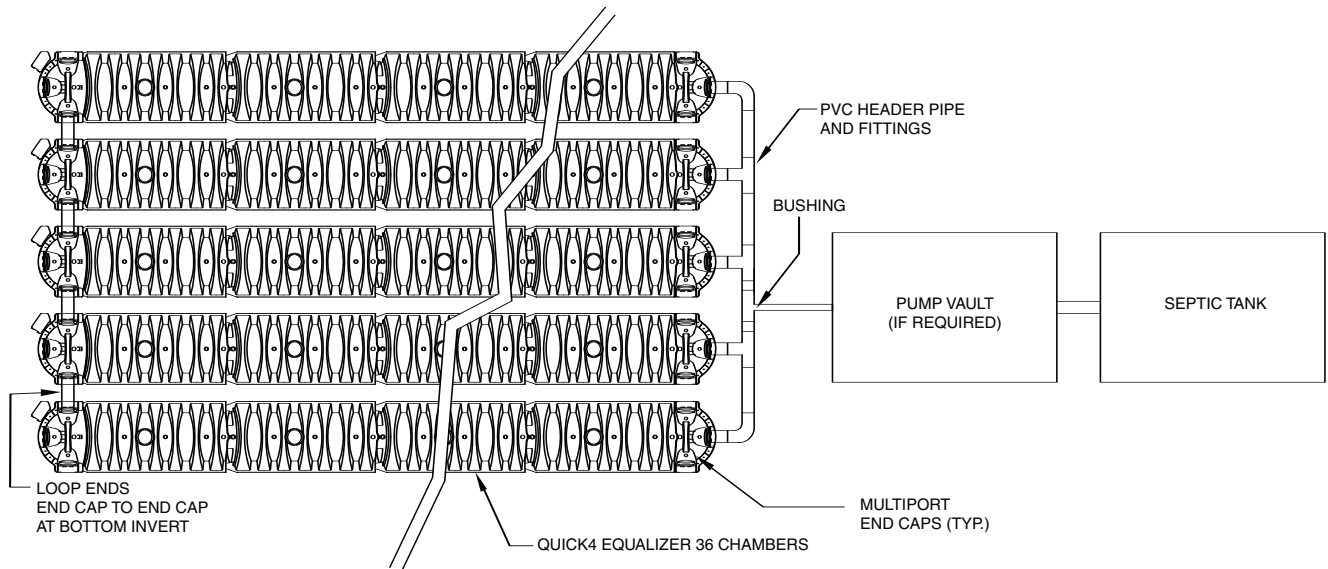

*Note: Quick4 EQ36 StraightLock Chambers can also be used in these configurations.*

# Quick4 Equalizer 36 Trench Configurations

## CROSS SECTION (not to scale)

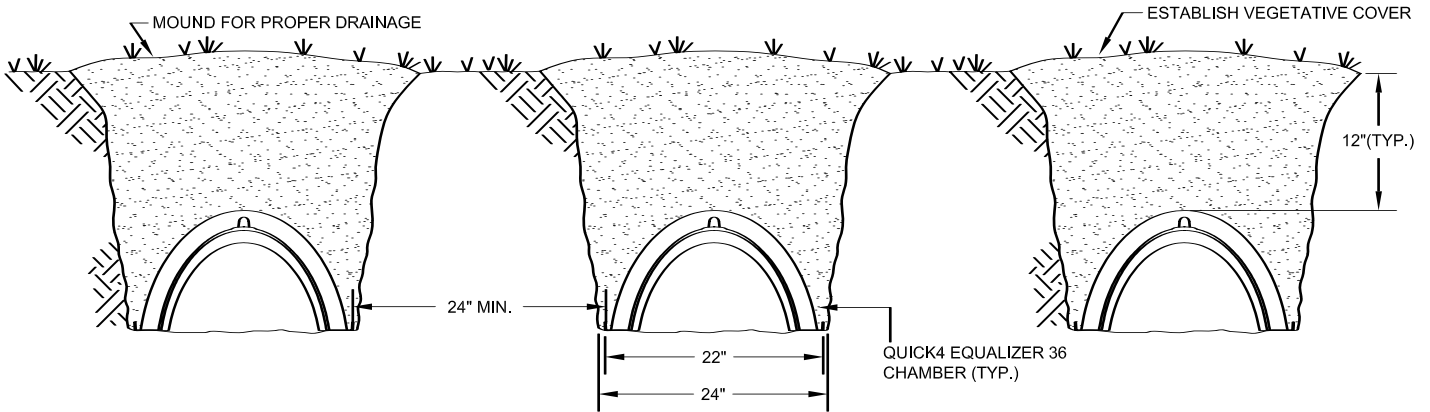

## PLAN VIEW (not to scale)

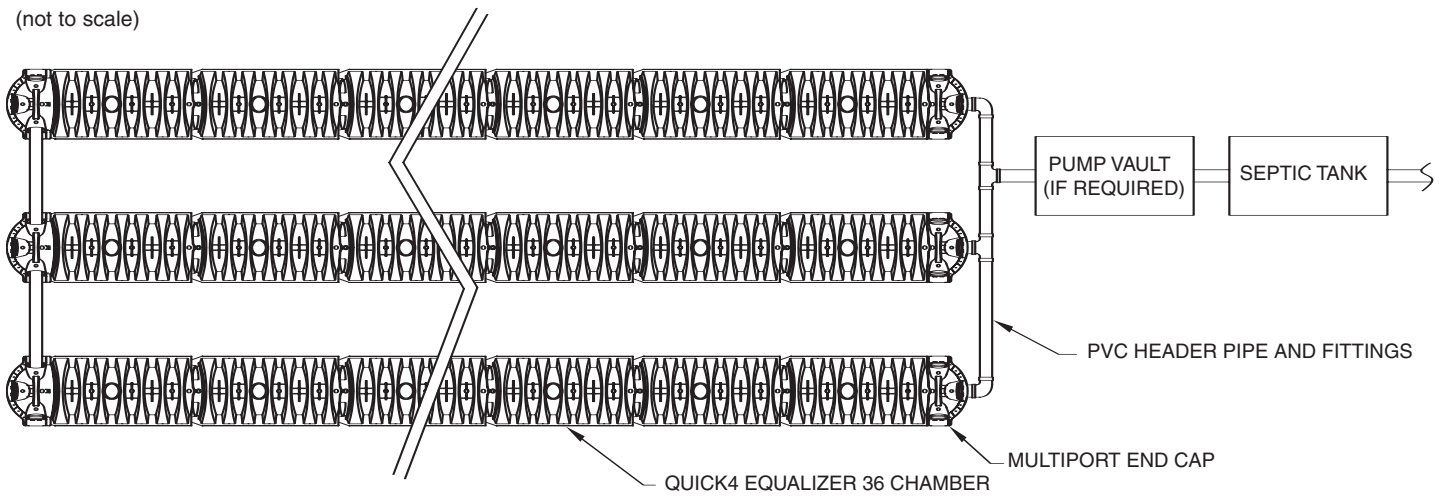

Note: Quick4 EQ36 StraightLock Chambers can also be used in these configurations.



## Bed Systems

### Before You Begin

**Quick4 EQ36 StraightLock Chambers may only be installed according to state and/or local regulations. If unsure of the installation requirements for a particular site, be sure to contact your local regulator.**

**Like conventional systems, the soil and site conditions must be approved prior to installation. Conduct a thorough site evaluation to determine the proper sizing and siting of the system before installation.**

#### Materials and Equipment Needed

- |  |  |
|--|--|
| <input type="checkbox"/> Quick4 EQ36 StraightLock Chambers     | <input type="checkbox"/> Tape Measure              |
| <input type="checkbox"/> MultiPort End Caps                    | <input type="checkbox"/> Utility Knife/Screwdriver |
| <input type="checkbox"/> 4" Diameter Pipe for Header and Inlet | <input type="checkbox"/> Screw Gun*                |
| <input type="checkbox"/> Backhoe/Excavator                     | <input type="checkbox"/> 2-inch Drywall Screws*    |
| <input type="checkbox"/> Laser, Transit, or Level              |  |
| <input type="checkbox"/> Shovel and Rake                       |  |

#### These guidelines for construction machinery must be followed during installation:

- Avoid direct contact with chambers when using construction equipment. Chambers require a 12-inch minimum of compacted cover to support a wheel load rating of 16,000 lbs/axle or equivalent to an H-10 AASHTO load rating.
- Only drive across the system when necessary.
- Never drive down the length of the system.
- To avoid additional soil compaction, never drive heavy vehicles over the completed system.

### Excavating and Preparing the Site

*Note: A State of Florida Department of Health Construction Permit (Form DH 4016) must be obtained before any system is constructed, modified or repaired. Form DH 4016 will specify all necessary information for constructing and repairing an onsite sewage system. Tank/drain field size, elevations, system configurations, and fill/excavation required can all be found on this form.*

**1.** Stake out the location of drainfield area. Set the elevations of the tank, pipe, and drainfield bottom in accordance with specifications on Form DH 4016.

**2.** Excavate and level drainfield area.

*Note: The bed should be installed level or no more than 1" per 10' of fall per Chapter 64E-6 of the Florida Administrative Code.*

### Preparing the MultiPort End Caps

*Note: See photos on page 11.*

- 1.** With a utility knife start the tear-out seal at the appropriate diameter for the inlet pipe. The seal allows for a tight fit for 4-inch SDR35, and 4-inch SCH40 pipe.
- 2.** Pull the tab on the tear-out seal to create an opening on the end cap.
- 3.** Snap off the molded splash plate located on the bottom front of the end cap.
- 4.** Install splash plate into the appropriate slots below the inlet to prevent trench bottom erosion.
- 5.** Insert the inlet pipe into the end cap at the beginning of the trench. The pipe will go in one inch before reaching a stop. (Screws optional.)

### Installing the System

**1.** Place the first chamber into the excavated and leveled area with the chamber-end marked "INLET" facing the tank/header.

**2.** Place the next chamber (inlet end facing tank/header) onto the previous one by overlapping the raised corrugation.



Connect the chambers.

*Note: If installing a bed system, check the spacing between the chambers to ensure approximately 4 to 6 inches of separation.*

**3.** To connect the chambers and engage the patent-pending StraightLock connection, simply push down on the chamber with your hand until it snaps into place. Note the locking tab engage through the opening in the chamber corrugation.



Engage the connection.

**4.** Continue installing chambers until the system is completed.

*Note: Due to various site locations, if chambers are installed with inlet side toward distal end, this will not affect systems performance.*

## Bed Systems

### Attaching the MultiPort End Caps

1. Lift up the open end of the chamber while sliding the end cap under the chamber.



Slide end cap under chamber.

2. Align the raised corrugation and lower the chamber so that it overlaps the end cap.

*Note: The end cap should be overlapped by the chamber on both the inlet and outlet ends.*

*Optional: Secure the end cap in place with a drywall screw.*

### Installing Header and Footer

1. Install the header assembly level with the inlet "T" and as close to the center of the system as possible. The header is installed to the upper opening of the end cap.

2. Pack the soil around the header to secure the assembly and provide support for easier leveling.

*Note: An optional drywall screw can be used at the 12 o'clock position to secure the pipe to the end cap. If a footer assembly is required (bed/mound) the side ports of the end cap may be connected using 24" sections of pipe.*

*Note: Either the top or bottom ports of the end cap may be used for continuous circuit in a bed.*

3. The system is now ready for Department of Health inspection.

### Installing Optional Inspection Ports

1. With a hole saw drill the pre-marked area in the top of the chamber to create a 4-inch opening.

2. Set a cut piece of pipe of the appropriate length into the corresponding chamber's inspection port sleeve.

*Note: The sleeve will accommodate a 4-inch SCH40 pipe.*

3. Use two screws to fasten the pipe to the sleeve around the inspection port.

4. Attach a threaded cap or cleanout assembly onto the protruding pipe at the appropriate height.

5. A small valve cover box may be used if inspection port is below the desired grade.

### Backfilling and Covering the System

**Before backfilling, the system must be inspected by a health officer or other official as required by State and local codes. Create an as-built drawing at this time for future records.**

1. Ladle soil with a backhoe bucket or carefully dump soil on the dome of the chambers and spread in between.



Ladle soil on chamber domes.

2. When placing final cover on the system, backfill by building a ramp of compacted soil (2 feet approx.) and broadcast the cover material over the system with a small-tracked dozer, backhoe, or Bobcat. Be sure to cover the system perpendicular to the chambers and do not drive heavy equipment lengthwise on the chambers.



Build ramp of soil.

*Note: Chapter 64 E-6 of the Florida Administrative Code requires a minimum of 6 inches of compacted cover on standard installation. Mounded and Fill*

*Systems require a soil cap of moderately limited soil over the drainfield and shoulder area. The soil cap shall be no less than 6 inches at the outer perimeter of the shoulder.*

3. Seed or sod the site (per state and local requirements), shortly after final cover and be sure that the area is graded for proper drainage.

**FIGURE 1: TYPICAL BED DETAIL**

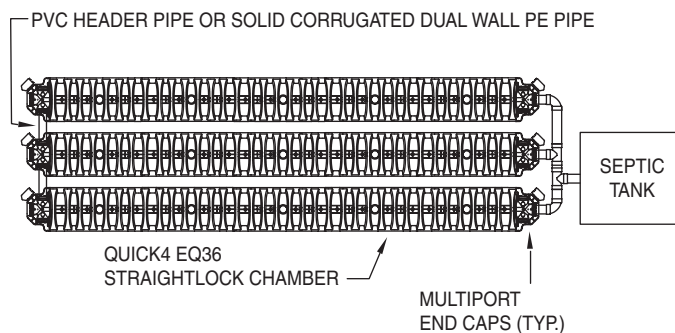

## Trench Systems

### Before You Begin

**Quick4 Chambers may only be installed according to State and/or local regulations. If unsure of the installation requirements for a particular site, contact the local health department.**

Like conventional systems, the soil and site conditions must be approved prior to installation. Conduct a thorough site evaluation to determine the proper sizing and siting of the system before installation.

#### Materials and Equipment Needed

- Quick4 Chambers
- MultiPort End Caps
- Backhoe/Excavator
- Laser, Transit, or Level
- Shovel and Rake
- Tape Measure
- Utility Knife/ Screwdriver
- Screw Gun\*
- 2-inch Drywall Screws\*
- \*Optional

#### These guidelines for construction machinery must be followed during installation:

- Avoid direct contact with chambers when using construction equipment. Chambers require a 12-inch minimum of compacted\*\* cover to support a wheel load rating of 16,000 lbs/axle or equivalent to an H-10 AASHTO load rating.
- Only drive across the trenches when necessary. Never drive down the length of the trenches.
- To avoid additional soil compaction, never drive heavy vehicles over the completed system.

\*\*Compacted to a comparable level of native soil.

### Excavating and Preparing the Site

*Note: A State of Florida Department of Health Construction Permit (Form DH 4016) must be obtained before any system is constructed, modified or repaired. Form DH 4016 will specify all necessary information for constructing and repairing an onsite sewage system. Tank/drain field size, elevations, system configurations, and fill/excavation required can all be found on this form.*

- 1.** Stake out the location of all trenches and lines. Set the elevations of the tank, pipe, and trench bottom in accordance with specifications on Form DH 4016.
- 2.** Install sedimentation and erosion control measures. Temporary drainage swales/berms may be installed to protect the site during rainfall events.
- 3.** Excavate and level 2-foot wide trenches with proper center-to-center separation. Verify that the trenches are approximately level or have the prescribed fall of no more than 1" per 10' of trench length.

*Note: Over excavate the trench width in areas where you are planning to contour.*

### Preparing the MultiPort End Cap

**1.** With a screwdriver or utility knife start the tear-out seal at the appropriate diameter for the inlet pipe. The seal allows for a tight fit for 3-inch, 4-inch SDR35, and 4-inch SCH40 pipe.



**1** Start tear-out seal.

**2.** Pull the tab on the tear-out seal to create an opening on the end cap.



**2** Pull tab on tear-out seal.

**3.** Snap off the molded splash plate located on the bottom front of the end cap.



**4** Install splash plate.

**4.** Install splash plate into the appropriate slots below the inlet to prevent trench bottom erosion.



**5** Insert inlet pipe.

**5.** Insert the inlet pipe into the end cap at the beginning of the trench. Extend the pipe into the end cap roughly 4 inches. (Screws optional.)

## Trench Systems

### Installing the System

**1.** Check the header pipe to be sure it is level or has the prescribed slope.

**2.** Place the inlet end of the first chamber over the back edge of the end cap.



**2** Place first chamber onto end cap.

**3.** Lift and place the end of the next chamber onto the previous chamber by holding it at a 45-degree angle. Line up the chamber end between the connector hook and locking pin at the top of the first chamber. Lower it to the ground to connect the chambers.



**3** Connect the chambers.

*Note: When the chamber end is placed between the connector hook and locking pin at a 45-degree angle, the pin will be visible from the back side of the chamber.*

*Note: The connector hook serves as a guide to ensure proper connection and does not add structural integrity to the chamber joint. Broken hooks will not affect the structure or void warranty.*

**4.** Swivel the chamber on the pin to the proper direction for the trench layout.

*Note: The chamber allows for 15 degrees of swivel in either direction at each joint.*

**5.** Where the system design requires straight runs, use the StraightLock Tabs to ensure straight connections. To activate the tabs, pop the tabs up with your thumb and lock into place.



**5** Activate StraightLock Tabs.

**6.** Continue connecting the chambers until the trench is completed.

**7.** The last chamber in the trench requires an end cap. Lift the end cap at a 45-degree angle and insert the connector hook through the opening on the top of the end cap. Applying firm pressure, lower the end cap to the ground to snap it into place. Do not remove the tear-out seal.



**7** Attach end cap to chamber.

*Note: Use straight lengths of pipe with the MultiPort End Cap at the trench ends to create fitting-free looped ends (continuous circuit).*

**8.** With the system ready for inspection, shoot the trench for level grade at the beginning, midpoint and end of trench.

**9.** To backfill the chambers, fill the sidewall area by pulling soil from the sides of the trench. Continue backfilling the entire sidewall area, making sure the fill covers the louvers.

**10.** Proceed to the next trench and begin with Step 1.

## Trench Systems

### Installing Optional Inspection Ports

1. With a hole saw drill the pre-marked area in the top of the chamber to create a 4-inch opening.
2. Set a cut piece of pipe of the appropriate length into the corresponding chamber's inspection port sleeve.

*Note: The sleeve will accommodate a 4-inch SCH40 pipe.*

3. Use two screws to fasten the pipe to the sleeve around the inspection port.



*Fasten the pipe.*

4. Attach a threaded cap or cleanout assembly onto the protruding pipe at the appropriate height.
5. A small valve cover box may be used if inspection port is below the desired grade.

### Covering the System

**Before backfilling, the system must be inspected by a health officer or other official as required by State and local codes. Create an as-built drawing at this time for future records.**

1. Backfill the trench by pushing fill material over the chambers with a backhoe. Keep a minimum of 12 inches of compacted cover over the chambers before driving over the system.

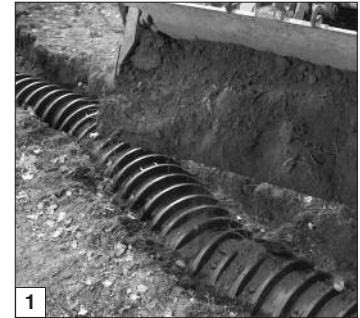

*Backfill trench.*

*Note: Do not drive over system while backfilling in sand.*

*Note: For shallow cover applications, you must mound 12 inches of soil over the system before driving over it, and then grade it back to 6 inches upon completion.*

2. It is best to mound several inches of soil over the finish grade to allow for settling. This also ensures that runoff water is diverted away from the system.
  3. After the system is covered, the site should be seeded or sodded (per state and local requirements) to prevent erosion.
- Note: If the system is for new home construction it is important to leave marking stakes along the boundary of the system. This will notify contractors of the site location so they will not cross it with equipment or vehicles.*

## Installing Filter Fabric\*

**Infiltrator Systems, Inc. suggests (non-mandatory) the installation of filter fabric over chambers when installed in uncompacted, fine/very-fine sands, and when the following conditions exist:**

- Installations left uncovered for extended periods of time (1 week or more).
- Drainfield area not sodded immediately after final cover-up.
- Drainfield area not protected from surface drainage (i.e. no gutters, run-off from paved areas).
- Drainfield located in area where infiltrative surface is less than 24" above seasonal high water table.

### Filter Fabric Specifications:

- Fabric shall be non-woven
- Weight: 0.35 oz./s.y. to 1 oz./s.y.
- Apparent Opening Size (AOS): 20-30 U.S. Sieve (ASTM D 4571)

*\*Note: No filter fabric is required or recommended when using Quick4 EQ36 StraightLock chambers.*

Place fabric lengthwise over chamber so sidewall is completely covered. See below.



## 90-Degree Bend Application

**BED DETAIL PLAN VIEW**  
(not to scale)

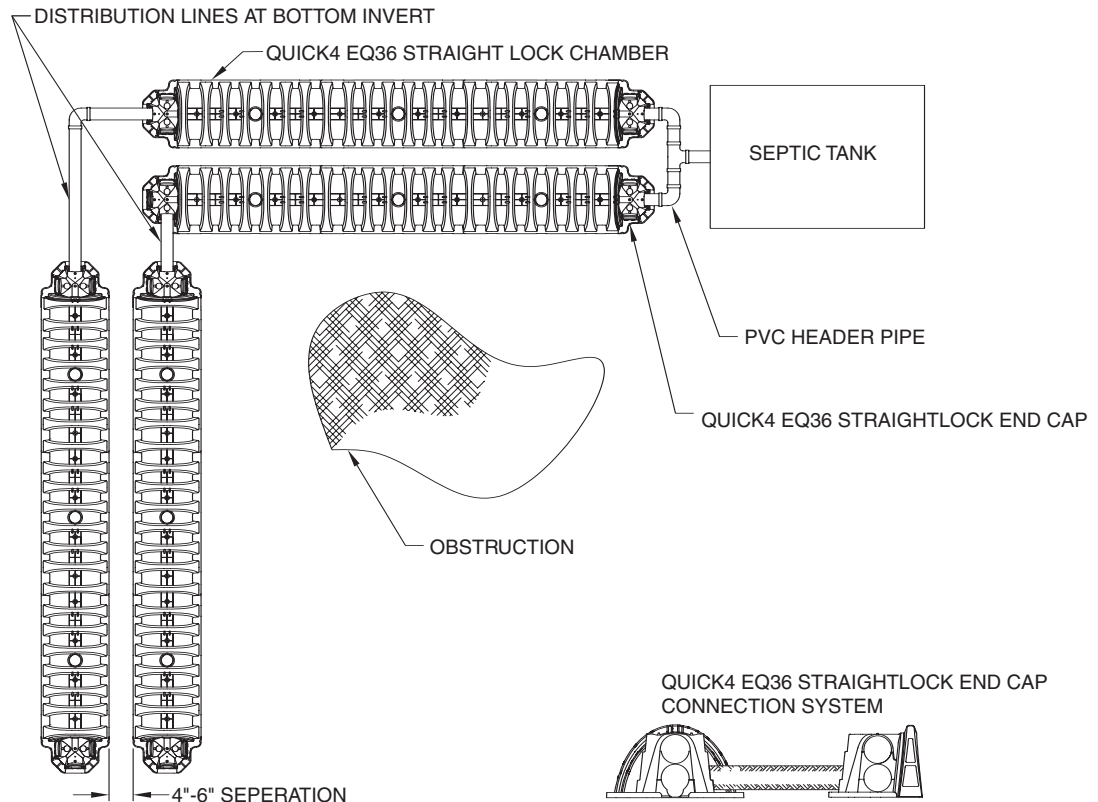

## Low Pressure Distribution Systems

*Note: Where the total required area of drainfield is greater than 1000 square feet, an automatic dosing device shall be used. The device discharges into a low-pressure distribution network designed by a registered engineer (Chapter 64E-6 State of Florida DOH Administrative Code).*

### Method A

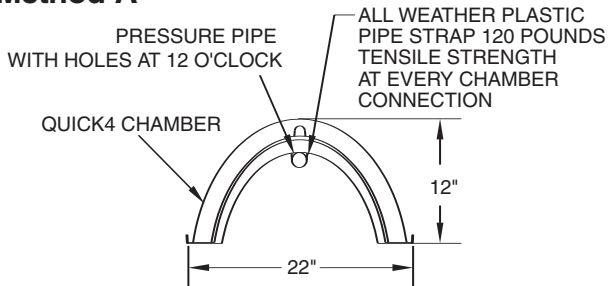

1. Use Schedule 40 PVC pipe and fittings ranging from 1¼"-2" (1¼" Typ.) as the discharge pipe to be suspended inside the chambers.
2. Connect piping to be used in the length of the field line by aligning the lettering on the pipe.
3. Drill specified holes at specified spacing along lettering to ensure a straight line. Mark the inlet end of the discharge pipe along lettering.
4. Connect all chambers at interlocking joints in a field line and secure each joint with a drywall screw on each side of the chamber.
5. Roll an entire row of chambers over so that the top of the chambers are lying on the soil and the feet of the chambers are facing upward.
6. Lay the discharge pipe inside the entire chamber field line and secure pipe with all-weather plastic tie straps spaced approximately every 4 feet. Be sure to leave about 1 foot of pipe stemming from the inlet end of the chamber for header connection. The distal end of the field line should be capped off inside the end cap of the last chamber.
7. Once the discharge pipe is secured, roll the row of chambers to an upright position.
8. With a hole saw, drill out the appropriate diameter hole in each end cap to accommodate pipe.
9. Insert the pipe through the hole in the end cap and slide the end cap to attach to the chamber field line.
10. Repeat these steps for each field line.
11. Connect the pipes stemming from the inlet end as the header assembly. Be sure that the mark on the pipe is facing the 12 o'clock position when connecting header. This is to ensure that the discharge holes are facing upward.
12. Backfill according to instructions.

### Method B

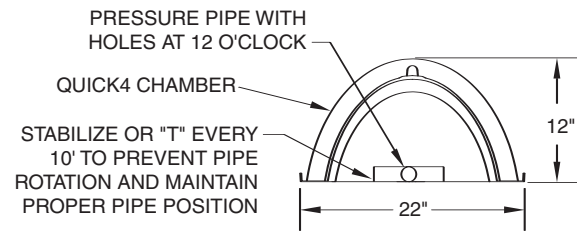

1. Use Schedule 40 PVC pipe and fittings ranging from 1¼" to 2" (1¼" Typ.) in diameter to be laid on the infiltrative surface underneath the chambers.
2. Connect piping to be used in the length of the field line by aligning the lettering on the pipe. The lettering should be facing upward. At every 10' section connect the pipe using a 4-way cross fitting. These fittings will stabilize the discharge pipe when the pump is switched on. Be sure to cap off the sides of the fittings not being used and the end of the field line.
3. Drill specified holes at specified spacing along lettering to ensure a straight line. Again, the holes must be facing upward.
4. Lay the pipe in the trench/bed and begin connecting the chambers over the discharge pipe. The pipe should be centered under the chambers. Leave about 1 foot of pipe stemming from the inlet-end of the chamber for header connection.
5. With a hole saw, drill out the appropriate diameter hole in each end cap to accommodate pipe.
6. Insert the pipe through the hole in the end cap and slide the end cap to attach to the chamber field line.
7. Repeat steps 1-4 for each field line.
8. Connect header assembly.
9. Backfill according to instructions.

# Florida Warranties

---

## Limited Septic Warranty for Infiltrator Chambers

(a) The structural integrity of each Infiltrator chamber and end cap, when installed in accordance with manufacturer's instructions, is warranted to the original purchaser against defective materials and workmanship for two years from the date of purchase. Should a defect appear within the warranty period, purchaser must inform Infiltrator Systems Inc. of the defect within fifteen (15) days. Infiltrator Systems will supply a replacement chamber and/or end cap. Infiltrator Systems' liability specifically excludes the cost of removal and/or installation of units.

(b) THE WARRANTY IN SUBPARAGRAPH (a) IS EXCLUSIVE. THERE ARE NO OTHER WARRANTIES WITH RESPECT TO THE CHAMBERS AND END CAPS, INCLUDING NO WARRANTIES OF MERCHANTABILITY OR OF FITNESS FOR A PARTICULAR PURPOSE. THE WARRANTY DOES NOT EXTEND TO INCIDENTAL, CONSEQUENTIAL, SPECIAL, OR INDIRECT DAMAGES. THE COMPANY SHALL NOT BE LIABLE FOR PENALTIES OR LIQUIDATED DAMAGES, INCLUDING LOSS OF PRODUCTION AND PROFITS, LABOR AND MATERIALS, OVERHEAD COSTS, OR OTHER LOSS OR EXPENSE INCURRED BY PURCHASER. SPECIFICALLY EXCLUDED FROM WARRANTY COVERAGE ARE DAMAGE TO THE UNITS DUE TO ORDINARY WEAR AND TEAR, ALTERATION, ACCIDENT, MISUSE, ABUSE, OR NEGLIGENCE OF THE UNITS; THE UNITS BEING SUBJECTED TO STRESSES GREATER THAN THOSE PRESCRIBED IN THE INSTALLATION INSTRUCTIONS; THE PLACEMENT BY PURCHASER OF IMPROPER MATERIALS INTO THE PURCHASER'S SYSTEM; OR ANY OTHER EVENT NOT CAUSED BY THE COMPANY. FURTHERMORE, IN NO EVENT SHALL THE COMPANY BE RESPONSIBLE FOR ANY LOSS OR DAMAGE TO THE PURCHASER, THE UNITS, OR ANY THIRD PARTY RESULTING FROM ITS INSTALLATION OR SHIPMENT. PURCHASER SHALL BE SOLELY RESPONSIBLE FOR ENSURING THAT THE INSTALLATION OF THE SYSTEM IS COMPLETED IN ACCORDANCE WITH ALL APPLICABLE LAWS, CODES, RULES, AND REGULATIONS.

(c) NO REPRESENTATIVE OF THE COMPANY HAS THE AUTHORITY TO CHANGE THIS WARRANTY IN ANY MANNER WHATSOEVER, OR TO EXTEND THIS WARRANTY. NO WARRANTY APPLIES TO ANY PARTY OTHER THAN TO THE ORIGINAL PURCHASER.

(d) All types of chamber systems must be installed in full compliance with the latest version of the product installation requirements. The system must be in full compliance with all aspects of the state regulations and codes.

## Performance Warranty for Quick4 Chambers

(a) Infiltrator warrants that each Quick4 chamber and MultiPort end cap manufactured by Infiltrator (collectively, the "Units"), when installed and operated in a leachfield of an onsite septic system of a single family residence in accordance with Infiltrator's instructions, for a period of two (2) years from the date of installation (i) shall be free from defective materials and workmanship; and (ii) shall perform in such a manner to absorb effluent within the design flow rate for the septic system containing the Units, so that there will be no sewage backup into the dwelling or structure which uses the septic system, or visible pooling of effluent around the system. The presence of such sewage backup or such visible pooling shall constitute a "failure" of the system. This Limited Warranty covers new permitted leachfield installations only, and does not cover repairs, extensions or additions to existing leachfields. This Limited Warranty extends only to the original purchasing contractor. For this Limited Warranty to apply, the Units must be installed in accordance with all necessary permits and in accordance with all site conditions required by state and local codes for the installation of gravel and pipe systems, and must be sized according to Infiltrator specifications and state, county and local requirements.

In order to exercise these Limited Warranty rights, the warranty holder must notify Infiltrator in writing at its corporate headquarters in Old Saybrook, Connecticut (address below) within fifteen (15) days of any alleged defect or failure. The notice shall be accompanied by (i) a letter from a state licensed septic tank contractor or Professional engineer detailing cause of failure (ii) a copy of the appropriate permit and design for the septic system; and (iii) proof to Infiltrator's satisfaction that the septic tank has been pumped at least once every three (3) years since installation. Upon notification of a possible breach of warranty, Infiltrator may undertake an investigation of the circumstances of the possible breach. At its discretion, Infiltrator may perform tests to determine the cause of any breach and may hire a soil scientist or professional engineer or use Infiltrator personnel to evaluate soil conditions and otherwise assist in the investigation.

In the event that Infiltrator determines that there has been a breach of this Limited Warranty due to a failure, Infiltrator will, at its option, either: provide Units as it deems necessary to extend the size of the leachfield and a fee of \$12.50 per Unit toward the cost of installation; or provide an equivalent, state-approved solution to cure the breach. Infiltrator will not be responsible for pumps or any other necessary mechanical devices needed to extend or repair the leachfield following a failure, nor shall Infiltrator be liable for the addition of pump systems or underground water diversion systems, or repair or replacement of any landscape or irrigation systems, following a Failure.

In the event of any other breach of this Limited Warranty, Infiltrator will, at its option, either: provide replacement Units for Units determined by Infiltrator to be defective and a fee of \$12.50 per Unit toward the cost of installation; or provide an equivalent state-approved solution to cure the breach. Infiltrator's liability under this Standard Limited Warranty specifically excludes any other cost of removal and/or installation of the Units.

(b) THIS LIMITED WARRANTY AND THE REMEDIES IN SUBPARAGRAPH (a) ARE EXCLUSIVE. THERE ARE NO OTHER WARRANTIES TO THE ORIGINAL PURCHASING CONTRACTOR WITH RESPECT TO THE UNITS, INCLUDING NO IMPLIED WARRANTIES OF MERCHANTABILITY OR FITNESS FOR A PARTICULAR PURPOSE.

(c) This Limited Warranty shall be void if any part of the chamber system (chamber or end cap) is manufactured by anyone other than Infiltrator. The Limited Warranty does not extend to incidental, consequential, special or indirect damages. Infiltrator shall not be liable for penalties or liquidated damages, including loss of production and profits, labor and materials, overhead costs, or other losses or expenses incurred by the warranty holder or any third party. Specifically excluded from Limited Warranty coverage are damage to the Units due to Acts of God or natural disasters; ordinary wear and tear, alteration, accident, misuse, abuse or neglect of the Units; the Units being subjected to vehicle traffic or other conditions which are not permitted by the installation instructions; failure to maintain the minimum ground cover set forth in the installation instructions; the placement of improper materials into the system containing the Units; failure of the Units or the septic system due to improper siting or improper sizing, improper specified backfill, excessive water usage, improper grease disposal, or improper operation; or any other event not caused by Infiltrator. This Limited Warranty shall be void if the warranty holder fails to comply with all of the terms set forth in this Limited Warranty, including the information required by subparagraph (a).

Furthermore, in no event shall Infiltrator be responsible for any loss or damage to the warranty holder, the Units, or any third party resulting from installation (except as expressly set forth in subparagraph (a) or shipment, or from product liability claims of the warranty holder or any third party. For this Limited Warranty to apply, the Units must be installed in accordance with all site conditions required by state and local codes, all other applicable laws, and Infiltrator's written instructions.

(d) No representative of Infiltrator has the authority to change this Limited Warranty in any manner whatsoever, or to extend this Limited Warranty. No warranty applies to any party other than the original purchasing contractor.

*NOTE: Any chamber systems constructed with less than our minimum sizing requirements will not be covered by any product warranties.*

*NOTE: In fine and very fine sands, loamy sand and sandy loam soils with low moisture content, it is at the contractor's discretion to cover the chambers with very fine filter cloth or paper prior to backfilling the system. Standard installation instructions apply.*



P.O. Box 768 • 6 Business Park Road • Old Saybrook, CT 06475  
860-577-7000 • FAX 860-577-7001

**www.infiltratorsystems.com**  
**1-800-221-4436**